

# OUTDOOR SIGNAGE



COSIGN

MODULAR SIGN SYSTEMS & WAY FINDING SOLUTIONS

# EXTERIOR / EXTERIEUR

## MODULAR

MODULE PLUS OUTDOOR 04

## LED SIGNS

LIGHTBOX 10

HIGHLIGHT 14

## TENSION

FRONTFLEX 16

TENSION PROFILES 20

## TOTEMS

TOTEM PROFILES 22

## CUSTOMISED SIGNS

TOTEM PYLONS 26

LIGHTBOXES 26

CHANNEL LETTERS 26

SPECIAL CONSTRUCTIONS 26

**HIGH QUALITY**

**CUSTOMISATION**

**INNOVATION**

**LARGE STOCK**

**EXPERIENCE**

**FLEXIBLE**

**SERVICE**

**QUALITÉ SUPÉRIEURE**

**PERSONNALISATION**

**INNOVATION**

**GRAND STOCK**

**EXPÉRIENCE**

**FLEXIBLE**

**SERVICE**

# COSIGN

MODULAR SIGN SYSTEMS



## YOUR GLOBAL PARTNER IN SIGN

Cosign was established in 1993. Over the last 30 years it has become the unsurpassed reference with regard to architectural signage.

No matter what type of signs you need, for indoor or outdoor use, flexible or modular, with or without LED technology, if desired with fabric, advertising pillars or spacers, Cosign is the right address.

Cosign is a global player with production facilities and distribution centres in Belgium (headquarters), India, Mexico, Brazil and Hong Kong.

Our extensive range of products is unique. We are able to deliver quickly due to our large supply of stock. 30 years of experience, well-organised logistical transactions and perfect service make Cosign a reliable partner that you can trust.

Cosign constantly works on innovative solutions for the sign industry together with top designers like Stefan Schöning, Bart Bauwens (IDnA) and Fabrique.

## VOTRE PARTENAIRE MONDIAL POUR LA SIGNALISATION

Cosign a été fondé en 1993 et au cours de ces 30 dernières années l'entreprise s'est transformée en une référence mondiale dans la signalisation architecturale.

Quel que soit le type de signalisation que vous recherchez - pour une application d'intérieur ou d'extérieur, flexible ou modulaire, avec ou sans technologie LED, avec ou sans toiles de textile, des totems publicitaires ou des entretoises - chez Cosign vous êtes certain d'être à la bonne enseigne.

Cosign est devenu un acteur de classe mondiale avec des facilités de production et de distribution en Belgique (siège principal), en Inde, au Mexique, Brésil et à Hong Kong.

Notre vaste gamme de produits n'est ni plus ni moins qu'unique. Grâce à notre grand stock nous sommes toujours en mesure de livrer rapidement. En sus de nos 30 années d'expérience, notre traitement logistique bien organisé et notre service parfait font que Cosign est un partenaire fiable sur lequel vous pouvez toujours compter.

Epaulé de designers de renom comme Stefan Schöning, Bart Bauwens (IDnA) et Fabrique, Cosign est sans cesse à la recherche de solutions innovantes pour l'industrie de la signalisation.

# MODULE PLUS OUTDOOR



[www.cosign.be/moduleplusoutdoor](http://www.cosign.be/moduleplusoutdoor)

## STYLISH MODULAR OUTDOOR SIGNS

With Module Plus Outdoor, Cosign has developed a modular system for outdoor signs that is often prescribed by architects and designers worldwide and that sign makers like to use because of its versatility and convenience and the option of making unique custom-made signs.

Module Plus Outdoor offers the perfect solution everywhere where a building or location needs to be indicated, a message must be presented or people must be shown the correct place regardless of whether this is for an industrial estate, a company or office building, a hospital, a school, a shopping center or a car park. Appropriate outdoor signs will also contribute towards strengthening a company's corporate identity.

The Module Plus Outdoor system consists of a series of round, square, triangular, octagonal and ellipse-shaped aluminium poles and text panels (box profiles) with a height of 46 mm, 60 mm, 100 mm, 120 mm, 150 mm, 200 mm and 250 mm. The text panels can be fixed by using special panel clamps. Other innovative accessories ensure that panels can be integrated which are made of different materials in any required size.

Recent innovations with regards to the poles, top caps and panel clamps will give the Module Plus Outdoor a very modern look. Cosign has added a 60mm and 80mm square pole and a 60mm and 90mm triangular one. The new injection molded aluminium top caps will be available in grey and black. The existing panel clamps have been modified to increase installation efficiency. All new items are compatible with the existing system and provide new innovative possibilities.



## SIGNALISATION EXTÉRIÈRE MODULAIRE PARTICULIÈREMENT RAFFINÉE

Avec le Module Plus Outdoor, Cosign a lancé un système modulaire de signalisation extérieure fréquemment prescrit par les architectes et designers du monde entier et souvent utilisé par les fabricants d'enseignes du fait de sa grande polyvalence, de sa facilité d'utilisation, et de la possibilité de réaliser des enseignes uniques entièrement sur mesure.

Le Module Plus Outdoor constitue la solution idéale chaque fois qu'il est nécessaire d'indiquer un bâtiment ou un lieu, d'afficher un message ou d'orienter les visiteurs vers un endroit particulier, que ce soit dans un zoning industriel, un bâtiment d'entreprise, un immeuble de bureaux, un hôpital, une école, un center commercial ou un parking. Une signalisation extérieure de qualité contribue également au renforcement de l'image de marque de l'entreprise.

Le système Module Plus Outdoor se compose d'une série de poteaux en aluminium de section ronde, carrée ou elliptique, ainsi que de panneaux à texte en aluminium (profilés du type caisson) d'une hauteur de 46, 60, 100, 120, 150, 200 ou 250 mm. Les panneaux à texte sont fixés à l'aide d'attaches spéciales. D'autres accessoires innovants permettent d'intégrer des panneaux de toute taille, fabriqués en différents types de matériaux.

Des innovations récentes en ce qui concerne les poteaux, les capuchons et les crampons donneront le Module Plus Outdoor un look très moderne. Cosign a ajouté un poteau carré de 60 mm et de 80 mm et un poteau triangulaire de 60 mm et de 90 mm. Les nouveaux capuchons seront produits par moulage sous pression en aluminium gris et noir. Les crampons existants ont été modifiés afin d'augmenter l'efficacité des l'installation. Tous les nouveaux éléments peuvent être utilisés avec le système actuel et offrent de nouvelles possibilités innovantes.



# PROFILES / PROFILÉS

## ALUMINIUM POLES / POTEAUX ALUMINIUM

### ROUND POLES / POTEAUX RONDS

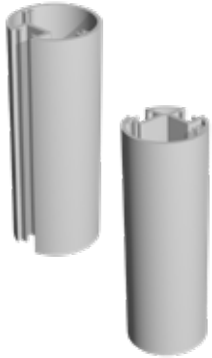

product code	description	
A00 1 60R1T	60mm round, 1-slot	6m/l
A00 1 60R2T	60mm round, 2-slots 60°	5m/l

1. mill finish brut 2. silver anodised anodisé naturel



product code	description	
A00 1 90R1T	90mm round, 1-slot	6m/l
A00 1 90R2T	90mm round, 2 slots 180°	5m/l

1. mill finish brut 2. silver anodised anodisé naturel

### NEW SQUARE POLES / POTEAUX CARRÉS

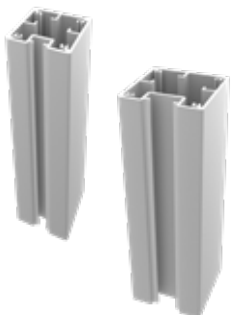

product code	description	
A00 1 60S1T	60mm square, 1-slot	6m/l
A00 1 80S1T	80mm square, 1-slot	6m/l

1. mill finish brut 2. silver anodised anodisé naturel

## TOPCAPS OF POLES / CAPUCHONS

### ROUND TOPCAPS / CAPUCHONS RONDS



product code	description	
AOTR601 1	60mm round, laser cut 2mm	60mm rond, coupé par laser 2mm

1. mill finish brut 2. silver anodised anodisé naturel



product code	description	
AOT600 1	60mm round, PP	60mm rond, PP

1. white/ blanc 2. grey/ gris 3. black/ noir



NEW

product code	description	
AOTR600 2	60mm round, die cast	60mm rond, moulé sous pression

2. grey powder coated laqué en gris 3. black powder coated laqué en noir



product code	description	
AOTR901 1	90mm round, laser cut 2mm	90mm rond, coupé par laser 2mm

1. mill finish brut 2. silver anodised anodisé naturel



NEW

product code	description	
AOTR900 2	90mm round, die cast	90mm rond, moulé sous pression

2. grey powder coated laqué en gris 3. black powder coated laqué en noir

### SQUARE TOPCAPS / CAPUCHONS CARRÉS



NEW

product code	description	
AOTS601 1	60mm square, laser cut 2mm	60mm carré, coupé par laser 2mm

1. mill finish brut 2. silver anodised anodisé naturel



NEW

product code	description	
AOTS600 2	60mm square, die cast	60mm carré, moulé sous pression

2. grey powder coated laqué en gris 3. black powder coated laqué en noir



NEW

product code	description	
AOTS801 1	80mm square, laser cut 2mm	80mm carré, coupé par laser 2mm

1. mill finish brut 2. silver anodised anodisé naturel



NEW

product code	description	
AOTS800 2	80mm square, die cast	80mm carré, moulé sous pression

2. grey powder coated laqué en gris 3. black powder coated laqué en noir

# PROFILES / PROFILÉS

## ALUMINIUM POLES / POTEAUX ALUMINIUM

NEW

### TRIANGULAR POLES POTEAUX TRIANGULAIRES



product code	description	
A00 1 60T1T	60mm triangular, 1-slot	6m/l
A00 1 90T1T	90mm triangular, 1-slot	6m/l

1. mill finish brut 2. silver anodised anodisé naturel

### OCTAGONAL POLES POTEAUX OCTOGONAUX

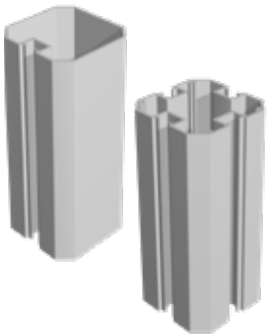

product code	description	
A00 1 8081T	80mm octagonal, 1-slot	5m/l
A00 1 8084T	80mm octagonal, 4-slots	5m/l

1. mill finish brut 2. silver anodised anodisé naturel

### ELLIPTICAL POLE POTEAU ELLIPTIQUE

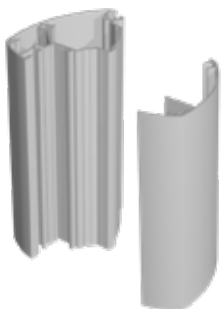

product code	description	
ELP 1 000	elliptical base profile	5m/l
ELP 1 001	elliptical hinge profile	5m/l

1. mill finish brut 2. silver anodised anodisé naturel

## TOPCAPS OF POLES / CAPUCHONS

### TRIANGULAR TOPCAPS CAPUCHONS TRIANGULAIRES



NEW

product code	description	
AOTT601 1	60mm triangular, laser cut 2mm	60mm triangulaire, coupé par laser 2mm

1. mill finish brut 2. silver anodised anodisé naturel



NEW

product code	description	
AOTT600 2	60mm triangular, die cast	60mm triangulaire, moulé sous pression

2. grey powder coated laqué en gris 3. black powder coated laqué en noir



NEW

product code	description	
AOTT901 1	90mm triangular, laser cut 2mm	90mm triangulaire, coupé par laser 2mm

1. mill finish brut 2. silver anodised anodisé naturel



NEW

product code	description	
AOTT900 2	90mm triangular, die cast	90mm triangulaire, moulé sous pression

2. grey powder coated laqué en gris 3. black powder coated laqué en noir

### OCTAGONAL TOPCAPS CAPUCHONS OCTOGONAUX



product code	description	
AOT8081	80mm octagonal, PP	80mm octogonaux, PP

1. white/ blanc 2. grey/ gris 3. black/ noir



product code	description	
AOT8084	80mm octagonal, 4 slots, PE	80mm octogonaux, 4 slots, PE

black acrylic / acrylic noir

### ELLIPTICAL TOPCAPS CAPUCHONS ELLIPTIQUES



product code	description	
AOTE101 1	elliptical topcap, laser cut 2mm	capuchon elliptique, coupé par laser 2mm

1. mill finish brut 2. silver anodised anodisé naturel

## ACCESSORIES / ACCESSOIRES

### DOUBLE SIDED TEXTPANELS / CAISSONS DOUBLE FACE

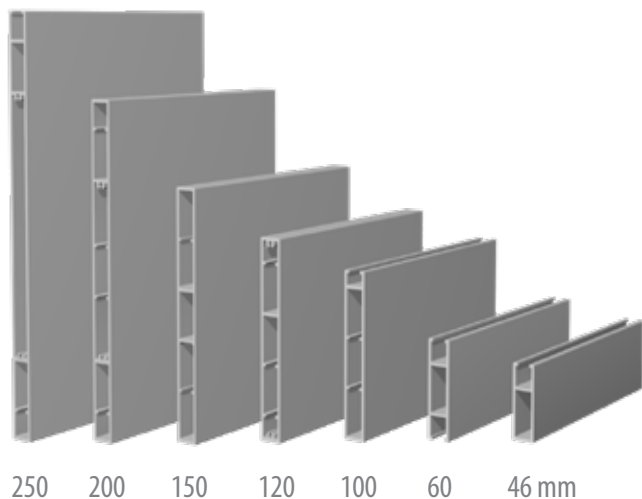

product code	description	
A00_1_250	250mm	5m/l
A00_1_200	200mm	5m/l
A00_1_150	150mm	5m/l
A00_1_120	120mm	5m/l
A00_1_100	100mm	5m/l
A00_1_060	60mm	5m/l
A00_1_046	46mm	5m/l

1. mill finish brut 2. silver anodised anodisé naturel

\* Note : text panel open on top side : 250, 100, 46 mm  
text panel open on both sides : 60 mm

### ALUMINIUM ENDCAPS PROFILÉS ALUMINIUM OBTURATEUR POUR CAISSONS

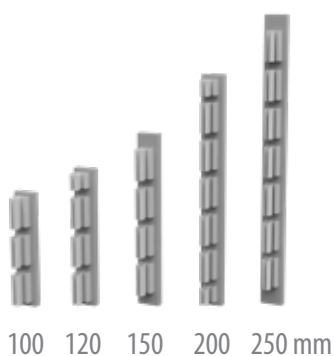

product code	description
AOC_1_250	250mm
AOC_1_200	200mm
AOC_1_150	150mm
AOC_1_120	120mm
AOC_1_100	100mm

1. mill finish brut 2. silver anodised anodisé naturel

### PANEL CLAMP CRAMPON DE FIXATION

	product code	description
	<b>NEW</b> AACL002	with inox screw / avec vis inox
	TOOL001	drilling guide for AACL002 / gabarit de perçage pour AACL002
	<b>UPDATE</b> FIXBOX001	without screw / sans vis





# ACCESSORIES / ACCESSOIRES

## STEEL FEET / PIEDS EN ACIER

product code	description
FEE1600	60mm round pole / poteau rond
DECOFEE2600	decorative foot / pied décoratif 60mm round pole / poteau rond
FEE19001T FEE19002T	90mm round pole / poteau rond 90mm round pole / poteau rond, 2-slots
FEE18081T FEE18084T	80mm pole / poteau octogonal 80mm pole / poteau octogonal, 4-slots
<b>NEW</b> FEE160ST FEE180ST	60mm square & triangular pole 60mm poteau carré et triangulaire 80mm square pole, 90mm triangular pole & elliptical pole 80mm poteau carré, 90mm poteau triangulaire & poteau elliptique

## FINISHING PROFILES / PROFILÉS DE FINITION

product code	description
AOCO_1_00	finishing profile / profilé de finition 5m/l 1. mill finish brut 2. silver anodised anodisé naturel
ADAPTER_1_0	adapter profile / profilé de connection 5m/l 1. mill finish brut 2. silver anodised anodisé naturel
AORO_1_00	reduction profile / profilé de reduction 5m/l 4mm plate material to be used instead of 8mm 1. mill finish brut 2. silver anodised anodisé naturel
AOC_1_000	finishing profile of elliptical pole / profilé de finition 5m/l 1. mill finish brut 2. silver anodised anodisé naturel

## ROUND CORNER CONNECTOR / ANGLE ARRONDI

product code	description
CORN_1_090	mill finish, for round pole 90mm brut, pour poteau rond 90mm

## SCREW CAP / BOUCHON À VIS

product code	description
NOP002	screw cap / bouchon à vis 1. white/ blanc 2. grey/ gris



# LIGHTBOX



[www.cosign.be/lightbox](http://www.cosign.be/lightbox)

Introducing the newest innovation from Cosign - our cutting-edge lightbox profiles for indoor and outdoor use which is perfect for creating illuminated advertising and wayfinding signs. Our lightbox profiles are versatile and available in four different depths, offering options for both single-sided use in 75mm and 120mm and double-sided use in 100mm and 160mm. The lightbox can be opened on one or two sides to insert the acrylic visual(s).

Our Lightbox profiles come in a mill finish (for proper powder coating in a specific RAL colour) or silver anodised finish. The profiles are available in a standard length of 6100mm or cut-to-size as easy-to-assemble semi-finished products. To ensure easy installation, we provide additional corners with bolts and nuts for the 75mm and 100mm double-walled profiles. The 120mm and 160mm depth profiles are single-walled with the ability to weld the corners to assure the lightbox is weatherproof ensuring your display to stay protected and visible in any environment. Optionally, we also deliver the option of edge- and backLED lighting modules and power supplies from Lucoled.

Our lightboxes are perfect for advertising or wayfinding purposes in various locations, including airports, shopping malls, metro stations, underground parkings, company buildings, and more. With our lightbox profiles, you can create remarkable displays that will grab attention and deliver your message effectively. They are built to last and are designed to withstand even the harshest outdoor conditions.

At Cosign, we strive to provide the highest quality products that meet the needs of our customers. Our lightbox profiles are no exception, designed with durability, versatility, and ease of installation in mind.



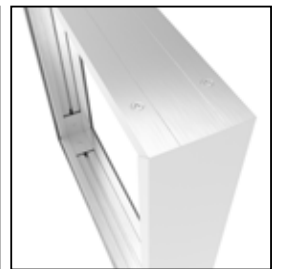
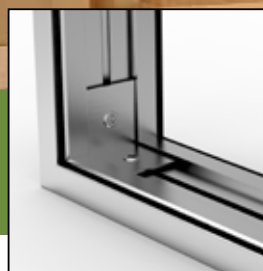

Présentation de la toute dernière innovation de Cosign - nos profilés de caissons lumineux pour une utilisation en intérieur et en extérieur, parfaits pour créer des publicités et enseignes lumineuses. Nos profilés de caissons lumineux sont polyvalents et disponibles en quatre profondeurs différentes, offrant des options pour une utilisation simple face en 75mm et 120mm et une utilisation double face en 100mm et 160 mm. Le caisson lumineux peut être ouvert sur un ou deux côtés pour insérer le(s) visuel(s) acrylique(s).

Nos profilés Lightbox sont disponibles en finition brute (pour un revêtement en poudre approprié dans une couleur RAL spécifique) ou anodisé naturel. Les profilés sont disponibles dans une longueur standard de 6100 mm ou découpés sur mesure sous forme de produits semi-finis faciles à assembler. Pour garantir une installation facile, nous fournissons des coins supplémentaires avec des boulons et écrous pour les profilés à double paroi de 75mm et 100mm. Les profilés de profondeur de 120mm et 160mm sont à paroi simple avec la possibilité de souder les coins pour garantir que la boîte à lumière est résistante aux intempéries, garantissant que votre enseigne lumineuse reste protégée et visible dans n'importe quel environnement. En option, nous livrons également l'option de modules d'éclairage edge- et backLED et d'alimentations de Lucoled.

Nos caissons lumineux sont parfaits pour la publicité ou l'orientation dans divers endroits, y compris les aéroports, les centres commerciaux, les stations de métro, les parkings souterrains, les bâtiments de l'entreprise, etc. Avec nos profilés lightbox, vous pouvez créer des affichages remarquables qui attireront l'attention et transmettront efficacement votre message. Ils sont construits pour durer et sont conçus pour résister aux conditions extérieures les plus difficiles.

Chez Cosign, nous nous efforçons de fournir des produits de la plus haute qualité qui répondent aux besoins de nos clients. Nos profilés de caissons lumineux ne font pas exception, conçus dans un souci de durabilité, de polyvalence et de facilité d'installation.

# PROFILES / PROFILÉS

## SINGLE SIDED LIGHTBOX PROFILES / PROFILÉS LIGHTBOX SIMPLE FACE

### LIGHTBOX 75mm



product code

description

**LB75-ST-SS10**

75mm, base profile, single sided 6,1m/l

1. mill finish brut 2. silver anodised anodisé naturel

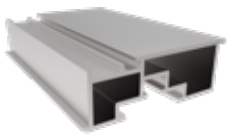
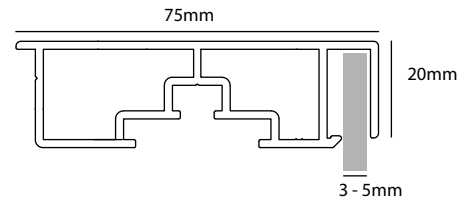

**LB75-01-SS10**

75mm, 1 open side, single sided 6,1m/l

1. mill finish brut 2. silver anodised anodisé naturel

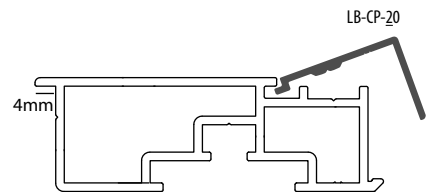

### LIGHTBOX 120mm

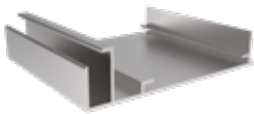

product code

description

**LB120-ST-SS10**

120mm, base profile, single sided 6,1m/l

1. mill finish brut

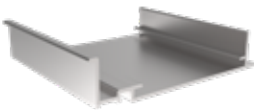
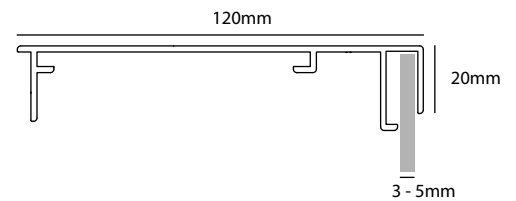

**LB120-01-SS10**

120mm, 1 open side, single sided 6,1m/l

1. mill finish brut

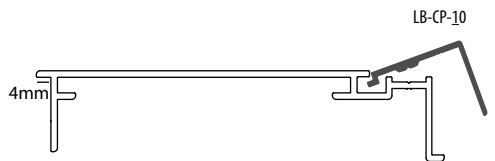

## CLAMPING AND CORNER PROFILES / PROFILÉS DE SERRAGE ET D'ANGLE



product code

description

**LB-CP-10**

Clamping profile lightbox 6,1m/l

1. mill finish brut 2. silver anodised anodisé naturel



product code

description

**LB-CORNER-10**

Corner profile 6,1m/l

6,1m/l

# PROFILES & ACCESSORIES / PROFILÉS & ACCESSOIRES

## DOUBLE SIDED LIGHTBOX PROFILES / PROFILÉS LIGHTBOX DOUBLE FACE

### LIGHTBOX 100mm



product code **LB100-ST-DS10** description 100mm, base profile, double sided 6,1m/l

1. mill finish brut 2. silver anodised anodisé naturel

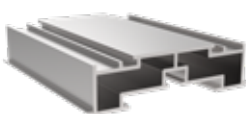
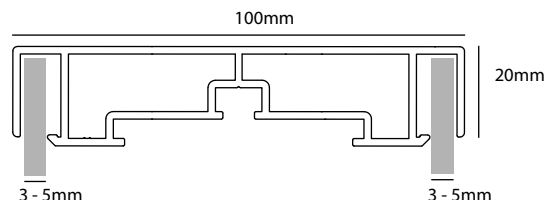

product code **LB100-02-DS10** description 100mm, 2 open sides, double sided 6,1m/l

1. mill finish brut 2. silver anodised anodisé naturel

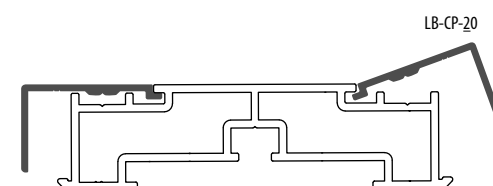

### LIGHTBOX 160mm



product code **LB160-ST-DS10** description 160mm, base profile, double sided 6,1m/l

1. mill finish brut

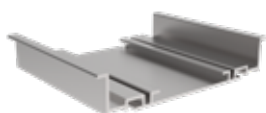
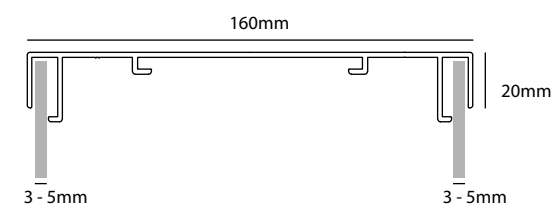

product code **LB160-02-DS10** description 160mm, 2 open sides, double sided 6,1m/l

1. mill finish brut

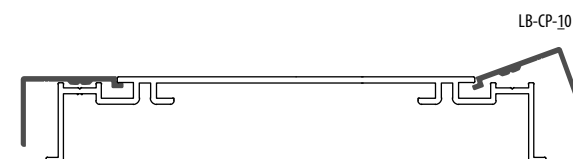

Note : Use clamping profile (LB-CP-10/20) to close the lightbox

## ACCESSORIES / ACCESSOIRES

product code **LB75-CORNER** description Lightbox 75mm, corner piece, mill finish - 30mm



product code **LB120-CORNER** description Lightbox 120mm, corner piece, mill finish - 80mm

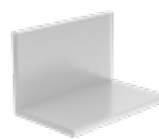

product code **LB100-CORNER** description Lightbox 100mm, corner piece, mill finish - 55mm

product code **LB160-CORNER** description Lightbox 160mm, corner piece, mill finish - 80mm



# HIGHLIGHT



[www.cosign.be/highlight](http://www.cosign.be/highlight)

Highlight is our LED luminaire profile which, in combination with the Lucoled EL37-W65 modules or other LED modules, provides the perfect solution for creating decorative wall washers or illuminating large surfaces like billboards, advertising signs, freestanding signs and totem pylons.

The elliptical shaped aluminium profile is supplied including endcaps, a special LED diffusing opal polycarbonate cover, easy-to-install wall brackets, spacer profiles and a hinge bracket which allows the profile to be set in the right angle to ensure an optimal light distribution.

La combinaison du Highlight, notre profilé pour luminaire LED, avec les modules Lucoled EL37-W65 ou autres modules LED offre la solution idéale pour créer des lèches-murs décoratifs ou illuminer de grandes surfaces telles que panneaux publicitaires, enseignes isolées, totems ou pylônes.

Le profilé aluminium de section elliptique est fourni avec les embouts, un couvercle diffuseur spécial LED en polycarbonate semi-opaque, des attaches murales faciles à installer, des profilés d'écartement et une attache charnière qui permet d'ajuster l'angle du profilé pour assurer une distribution optimale de la lumière.



# PROFILES & ACCESSORIES / PROFILÉS & ACCESSOIRES

## ALUMINIUM PROFILES PROFILÉS ALUMINIUM



product code: **HL-PROF 1 000**  
 description: **highlightprofile** / profilé de highlight  
 6,1m/l  
 1. mill finish brut 2. silver anodised anodisé naturel

## ENDCAP / CAPUCHON



product code: **HL-CAP 1 000**  
 description: **endcap / capuchon**  
 1. mill finish brut 2. silver anodised anodisé naturel

## WALL BRACKET / SUPPORT DE MONTAGE



product code: **HL-WB 1 000**  
 description: **wall bracket / support de montage**  
 1. mill finish brut 2. silver anodised anodisé naturel

## COVER PROFILE / PROFIL ---



product code: **HL-PC-OPAL**  
 description: **Polycarbonate cover profile** 6,1m/l

## SPACER / SUPPORT DE MONTAGE



product code: **HL-SP 1 000**  
 description: **spacer 30x30x2mm** 3m/l  
 1. mill finish brut 2. silver anodised anodisé naturel

## HINGE BRACKET / SUPPORT DE MONTAGE



product code: **HL-HB 1 000**  
 description: **hinge bracket**  
 1. mill finish brut 2. silver anodised anodisé naturel

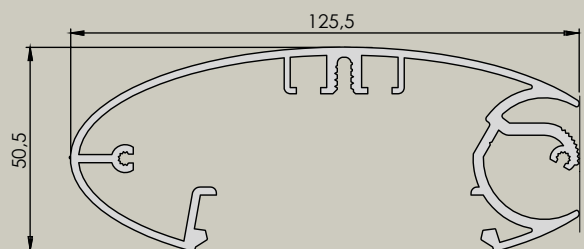
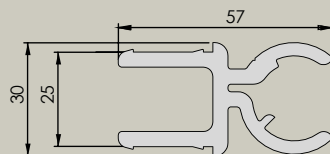
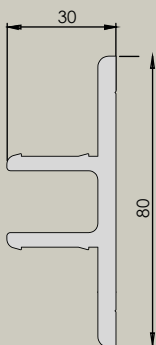

# FRONTFLEX



[www.cosign.be/frontflex](http://www.cosign.be/frontflex)

With our new Frontflex system, large-scale and long-lasting façade advertising or illuminated signs can be created in outdoor areas. Frontflex systems are quick to install, easy to maintain and cost-effective to change, as the fabric can effortlessly be replaced. Front or backlit fabrics can be precisely tensioned using our stable 120mm and 180mm aluminium profiles and our unique flexholder technology which allows large areas to be spanned as tight as a drum and without a single crease. With our 84mm and 97mm retrofit profiles, existing structures can be used without having to start from scratch. The depths of our profiles allow for an optimal and cost-effective LED illumination.

The aesthetic frameless design of our Frontflex profiles means that the digitally printed fabrics and motifs can run right up to the outer edge of the frame. The profiles are bendable and offer a wide variety of design options for events, exhibitions and shopfronts.

Frontflex = endless possibilities with a quality that lasts.







Avec notre nouveau système Frontflex, il est possible de créer des publicités de façade ou des enseignes lumineuses à grande échelle et de longue durée dans les espaces extérieurs. Les systèmes Frontflex sont rapides à installer, faciles à entretenir et économiques à changer, car le tissu peut être remplacé facilement. Les tissus avant ou rétroéclairés peuvent être tendus avec précision à l'aide de nos profilés en aluminium de 120 mm et 180 mm et de notre technologie unique de support flexible qui permet de couvrir de grandes surfaces aussi serrées qu'un tambour et sans un seul pli. Avec nos profilés de rénovation de 84 mm et 97 mm, les structures existantes peuvent être utilisées sans avoir à repartir de zéro. Les profondeurs de nos profilés permettent un éclairage LED optimal et économique.

La conception esthétique sans cadre de nos profilés Frontflex signifie que les tissus et motifs imprimés peuvent s'étendre jusqu'au bord extérieur du cadre. Les profilés sont pliables et offrent une grande variété d'options de conception pour les événements, les expositions et les devantures de magasins.





Frontflex = des possibilités infinies avec une qualité qui dure.

# PROFILES / PROFILÉS

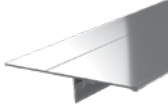

## FRAME PROFILES / PROFILÉS DE CADRE

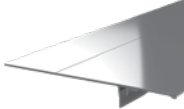

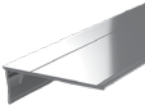
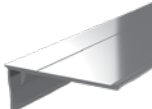
	product code	description	
	BASIC120	Basic profile 120mm, mill finish	6m/l
	BASIC180	Basic profile 180mm, mill finish	6m/l
	RETROFIT84	Retrofit 84mm, mill finish	6m/l
	RETROFIT97	Retrofit 97mm, mill finish	6m/l

## COVER PROFILES / PROFILÉS DE COUVERTURE

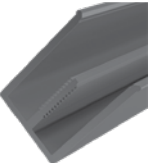
	product code	description	
	WIDECOVER120	Frameless wide cover 120mm, mill finish	6m/l
	WIDECOVER120-A	Frameless wide cover 120mm, silver anodised	6m/l
	WIDECOVER180	Frameless wide cover 180mm, mill finish	6m/l
	WIDECOVER180-A	Frameless wide cover 180mm, silver anodised	6m/l
	FLATCOVER1	Frameless cover for all basic profiles and 84mm retrofit, mill finish	6m/l
	FLATCOVER2	Frameless cover for 97mm retrofit, mill finish	6m/l

## CORNER PROFILES / PROFILÉS D'ANGLE



	product code	description	
	CORNERPROFILE	Corner & divider profile, mill finish	6m/l
	OUTCORNER	Outer corner cover, mill finish	6m/l

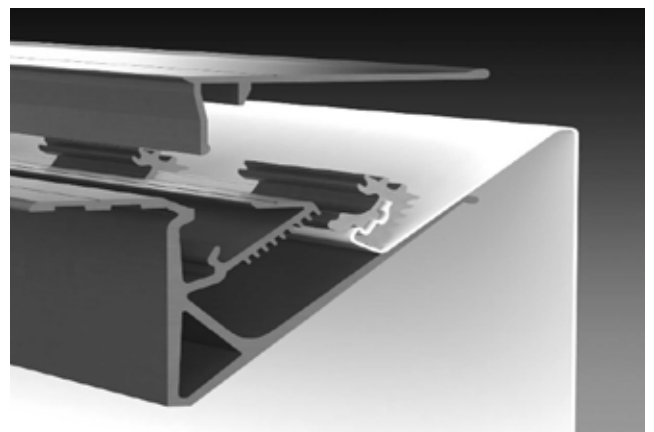
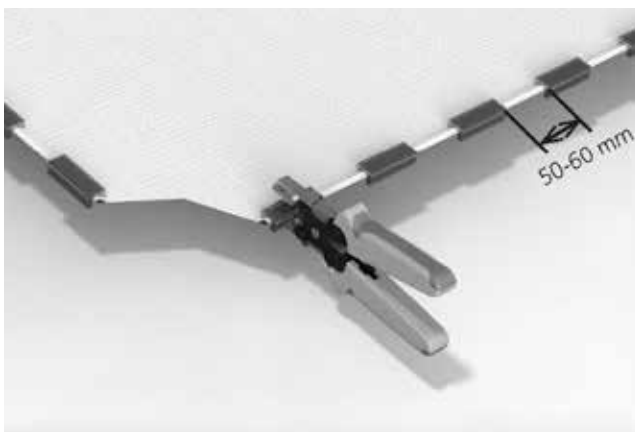



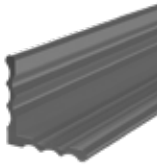
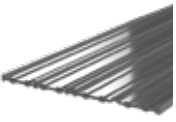
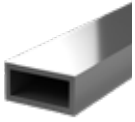

	product code	description	
	DIVCORNER	Divider corner cover, mill finish	6m/l
	INNCORNER	Inner corner cover, mill finish	6m/l



# ACCESSORIES / ACCESSOIRES

## ACCESSORIES / ACCESSOIRES

	product code	description	
	<b>CORNER120</b>	Corner BASIC120, mill finish	
	<b>CORNER180</b>	Corner BASIC180, mill finish	
	<b>JOINPLATE120</b>	Joiner plate for BASIC120 (34 x 150mm), mill finish	
	<b>JOINPLATE180</b>	Joiner plate for BASIC180 (73 x 150mm), mill finish	
	<b>SUPPORTREC</b>	Rectangular support 40 x 20 x 3mm, for basic profile 120mm, mill finish	6m/l
	<b>SUPPORTSQU</b>	Square support 40 x 40 x 3 mm, for basic profile 180mm, mill finish	6m/l
	<b>CONNECTORCROSS</b>	Cross connector for support profiles	

	product code	description	
	<b>FLEXHOLDER</b>	Flex holder, mill finish	
	<b>SHORTFLEXHOLDER</b>	Short flex holder, for radii, mill finish	
	<b>HAMMER</b>	Rubber hammer Frontflex	
	<b>FASTENER</b>	Front Flex fastener	
	<b>TENTOOL</b>	Tensioning tool	
	<b>COVERREMOVER</b>	Cover remover, to release the cover profiles	
	<b>FLEXHOLDERPLIER</b>	For squeezing and releasing of the Flex Holders	

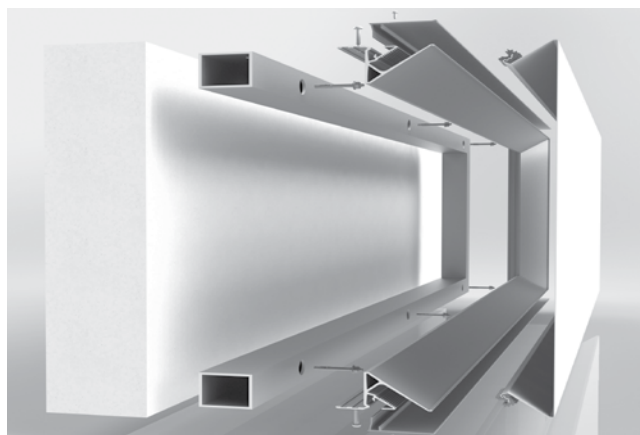

# TENSION PROFILES



[www.cosign.be/tensionprofiles](http://www.cosign.be/tensionprofiles)

The Cosign Tension System is one of the most popular solutions for the professional installation of banners, flexface and other printed textiles including mesh and canvas. A very simple and versatile product, it is easy to use and requires no special tools.

It is the perfect solution for a wide range of graphics and display projects.:

- Indoor and Outdoor signage projects
- Lightboxes
- Building wraps

Le système Tension de Cosign est une des solutions les plus largement utilisées pour le montage professionnel de bannières, de Flexface et d'autres textiles imprimés comme la toile ou le tissu de maille. Un produit très simple et versatile, il est facile à utiliser et ne requiert aucun outil spécial.





Le système est la solution idéale pour un large éventail de projets de graphisme et d'affichage :

- Projets de signalétique intérieure et extérieure
- Enseignes lumineuses
- Habillages de bâtiments





# PROFILES & ACCESSORIES / PROFILÉS & ACCESSOIRES

## TENSION PROFILES PROFILÉS TENSION

	product code <b>U SECTION10</b>	description U profile / profilé U	3,06m/l
	product code <b>U+ SECTION10</b>	description U+ profile / profilé U+	3,06m/l
	product code <b>UU SECTION10</b>	description UU profile / profilé UU	3,06m/l
	product code <b>UU COVER20</b>	description UU cover profile anodised Profilé de couverture pour profilé UU	3,06m/l

## TENSION PROFILES PROFILÉS TENSION

	product code <b>U2 SECTION10</b>	description U2 profile / profilé U2	3,06m/l
	product code <b>UU2 SECTION10</b>	description UU2 profile / profilé UU2	3,06m/l

## ACCESSOIRES FOR TENSION PROFILES ACCESSOIRES POUR PROFILÉS TENSION

	product code <b>PLASTICTSBLACK</b>	description Tension Strip black / Strip tension noir
	product code <b>PLASTICTSGREY</b>	description Tension Strip grey / Strip tension gris
	product code <b>PLASTICTSWHITE</b>	description Tension Strip white / Strip tension blanc
* Material: Polycarbonate (advanced) * Application: Indoor & outdoor single use only (no re-installation advised)		
	product code <b>UUSPRING</b>	description Spring Clips for UU cover Clips couverture UU
	product code <b>CORNERCON</b>	description Corner connector for U2 and UU2 profile Connecteur d'angle pour U2 et UU2 profilé
	product code <b>STRAIGHTCON</b>	description Straight connector for U2 and UU2 profile Connecteur pour U2 et UU2 profilé

### U PROFILE / PROFILÉ U



### U+ PROFILE / PROFILÉ U+



### UU PROFILE / PROFILÉ UU



# TOTEM PROFILES



[www.cosign.be/totemprofiles](http://www.cosign.be/totemprofiles)

## TOP-CLASS

Advertising pillars are omnipresent on today's street scene. A carefully designed advertising pillar makes you easier to find and contributes to the brand awareness and corporate identity of a company.

Cosign is an important manufacturer of profiles and accessories required for building advertising pillars or totems in the Benelux and we only deliver to the sign industry. Everyone is familiar with the 'classic' totem profiles, which are used to make illuminated or non-illuminated elegant, curved or elliptical advertising pillars. Depending on the application, location and desired size, the sign maker can choose our totem pylon 50 mm or totem pylon 80 mm for smaller totems (up to 3 metres) or our totem pylon 137 mm and the more recent H-profile for larger totems (up to 6 metres).

Depending on the chosen profile and internal structure, the sign maker can make small, elegant indoor totems as well as large, sturdy totems of up to 6 metres high.



## GRANDE CLASSE

On n' imagine plus de nos jours les rues sans totems publicitaires. Une colonne publicitaire astucieusement conçue non seulement met les gens sur la bonne voie, elle contribue aussi à une notoriété et à une image de marque accrues de l'entreprise.

Dans le Benelux, Cosign est un fabricant important de profils et d'accessoires nécessaires pour ériger des colonnes publicitaires ou totems et il ne livre qu'à l'industrie de la signalisation. Tout le monde les connaît, les profils de totem 'classiques' qui permettent de fabriquer d'élégantes colonnes publicitaires courbées ou de forme elliptique, avec ou sans éclairage. En fonction de l'application, de l'emplacement et de la taille voulue, le fabricant a le choix parmi notre totem pylon 50 mm et le totem pylon 80 mm pour les totems plus petits (jusqu'à 3 mètres), et le totem pylon 137 mm et le plus récent profil en H pour les totems plus grands (pouvant atteindre 6 mètres).

En fonction du profil choisi et de la structure interne, le fabricant de signalisations peut réaliser aussi bien de petits totems d'intérieur élégants que de grands totems solides pouvant atteindre une hauteur de 6 mètres.

# PROFILES / PROFILÉS

## ELLIPSE 50mm ÉLLIPSE 50mm

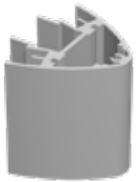

product code    profile / profilé

**TOT 1 050**    50mm    6m/l

- 1. mill finish    2. silver anodised    3. color
- brut    anodisé naturel    couleur



Double sided sign support 46mm (A001046)  
Caisson 46mm (A001046)

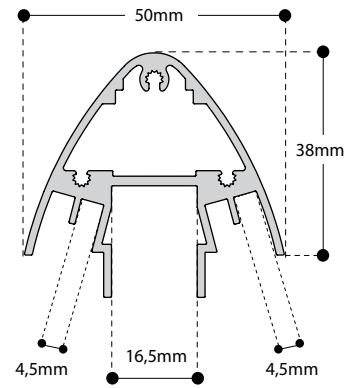

## ELLIPSE 80mm ÉLLIPSE 80mm

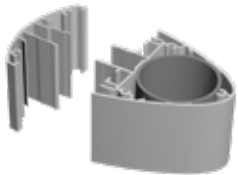

product code    profile / profilé

**TOT 1 080**    80mm    6m/l

- 1. mill finish    2. silver anodised    3. color
- brut    anodisé naturel    couleur



Round tube 50 x 4mm  
Tube rond 50 x 4mm

**TOTCLOSE1080**    afsluiting / couverture    6m/l

- 1. mill finish    2. silver anodised    3. color
- brut    anodisé naturel    couleur

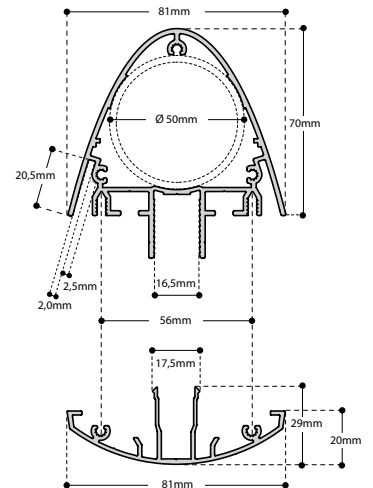



# PROFILES / PROFILÉS

## ELLIPSE 137mm ÉLLIPSE 137mm

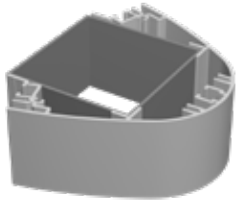

product code      profile / profilé

TOT 1 137

137mm

6m/l

- 1. mill finish brut
- 2. silver anodised anodisé naturel
- 3. color couleur

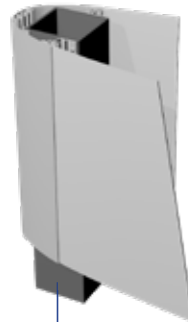

Aluminium or steel profile 80 x 80 x 4mm  
Tube de fondation 80 x 80 x 4mm

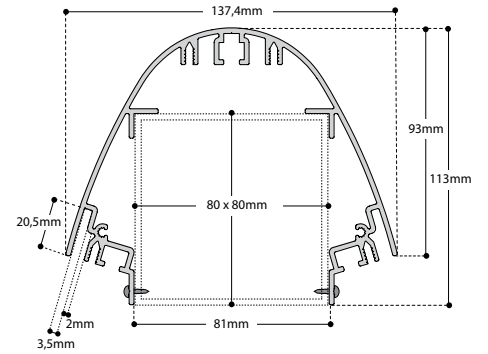

## H-PROFILE PROFILE-H

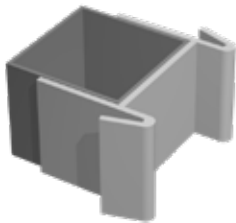

product code      profile / profilé

TOTH 1 060

H, 60mm

6m/l

- 1. mill finish brut
- 2. silver anodised anodisé naturel
- 3. color couleur



Aluminium or steel profile 60 x 60 x 4mm  
Tube de fondation 60 x 60 x 4mm

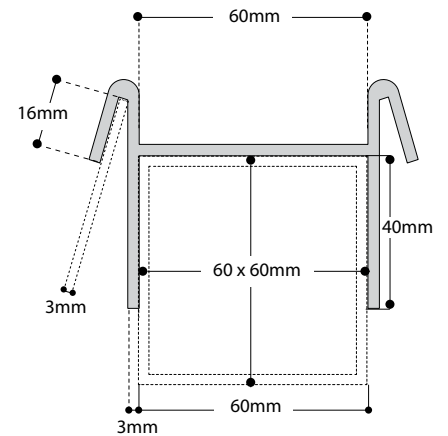

# CUSTOMISED SIGNS



[www.cosign.be/customised-signs](http://www.cosign.be/customised-signs)

Over the past 15 years, Cosign has invested heavily in the development of an international network with subsidiaries in Mexico, Brazil, India and Hong Kong. A number of joint ventures and partnerships were also started up in Western and Eastern Europe. This network makes it possible for Cosign to offer virtually any custom sign to sign makers, at the best prices and made by the best professionals. Whether it concerns totem pylons, light boxes, facade letters, special constructions, interior signage made of any material or LED Neon lighting, Cosign supplies it all. You provide us with a design or layout and we do the rest and deliver you a fantastic end product. If you wish, we can also take care of the necessary technical studies and installation.

Au cours des 15 dernières années, Cosign a fortement investi dans le développement d'un réseau international avec des filiales au Mexique, au Brésil, en Inde et à Hong Kong. Un certain nombre de coentreprises et de partenariats ont également été créés en Europe de l'Ouest et de l'Est. Ce réseau permet à Cosign de proposer pratiquement n'importe quelle enseigne personnalisée aux fabricants d'enseignes, aux meilleurs prix et réalisée par les meilleurs professionnels. Qu'il s'agisse de colonnes, de caissons lumineux, de lettres de façade, de constructions spéciales, de signalisation intérieure en tout matériau ou d'éclairage au néon LED, Cosign fournit tout. Vous nous fournissez une conception ou une mise en page et nous faisons le reste et vous livrons un produit final fantastique. Si vous le souhaitez, nous pouvons également nous charger des études techniques et de l'installation nécessaires.



## CUSTOMISED SIGNS / ENSEIGNES PERSONALISÉES

### TOTEM PYLONS TOTEMS ET PYLÔNES



### LIGHTBOXES CAISSONS LUMINEUX



### CHANNEL LETTERS LETTRES DE FAÇADE



### SPECIAL CONSTRUCTIONS CONSTRUCTIONS SPÉCIALES



# COSIGN

OUTDOOR SIGNAGE



INDOOR SIGNAGE | OUTDOOR SIGNAGE | FRAMES & DISPLAYS | LED SOLUTIONS

Cosign is a designer, manufacturer and distributor of architectural signage & way finding, poster frames & displays and LED signage solutions. Based in Belgium with regional offices in Mexico, Brazil and India, and through our global partner network, our sign solutions are available in more than 85 countries.

Cosign est un concepteur, fabricant et distributeur de solutions de signalétique & orientation architecturale, de cadres & supports de posters et solutions de signalisation LED. Nous sommes basés en Belgique et possédons des antennes régionales au Mexique, Brésil et en Inde. Grâce à notre réseau mondial de partenaires, nos solutions d'affichage sont disponibles dans plus de 85 pays.

**COSIGN**  
MODULAR SIGN SYSTEMS

COSIGN nv  
Industriepark 32 B  
B-3290 Diest  
Belgium  
[www.cosign.be](http://www.cosign.be)



YOUR DEALER / VOTRE REVENDEUR: